

B-TYPE

CLASS

Classification	Lloyd's Register ✱100 A1, DP(AA)
Ice-Class	1A Finnish/ Swedish
Special Purpose Ship	Yes
Open top sailing notation	Yes
Fitted for carriage of dangerous goods of all IMO classes	
Fitted for carriage of INF2 cargo	
Fitted for trading Australia	

ACCOMMODATION

Up to 60 persons (including ship's crew)
Client and/or project personnel in mutual agreement

PRINCIPAL DIMENSIONS

Length over all	141.30 m		
Breadth moulded	24.91 m		
		Panama	Suez
GT	Abt. 14,498	14,498	16,115.40
NT	Abt. 5,179	12,159	13,430.09
DEADWEIGHT all told	12,332 mt	Draft 8.20 m	
DEADWEIGHT SPS dual hold	open top - 10,226 mt	Draft 7.50 m	
DEADWEIGHT closed top	14,517 mt	Draft 8.92 m	

CARGO HOLD CAPACITY

Grain = bale	18,884 m ³
--------------	-----------------------

PROPULSION & POWER GENERATION SYSTEM

Main engine	9L32 5,220 kW
Auxiliary generators	4x 2,000 kW
Bowthrusters	2x 1,950 kW
Sternthrusters	2x 1,100 kW
Retractable thrusters	2x 1,800 kW

DP CAPABILITIES

BFT 6 (Vw: 27 kn / Vc: 1.5 kn / HS: 3.1 m / TP 8.5 sec)

20% dynamic factor, single failure

Closed ring

HiPAP ready

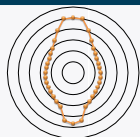

FLOOR SPACE

	Strength	Area	Dimensions
Tanktop	20 mt/ m ²	1,450 m ²	82.3 x 17.8 m
Tween deck	5 mt /m ²	1,575 m ²	89.2 x 17.8 m
Weather deck	4 mt /m ²	2,875 m ²	121 x 24.8 m

CONTAINER CAPACITY

Total	941 TEU
-------	---------

PIPE HANDLING CRANE SYSTEM

BFT 6
1.000 joints / day
SWL 135 mt
Removable

DECK CRANES

Position	2 x port side
Tons /reach	500 mt SWL / 16.5 m
	300 mt SWL / 27 m
	141 mt SWL / 37 m
Tugger Winches (constant tention and manual mode)	16 mt

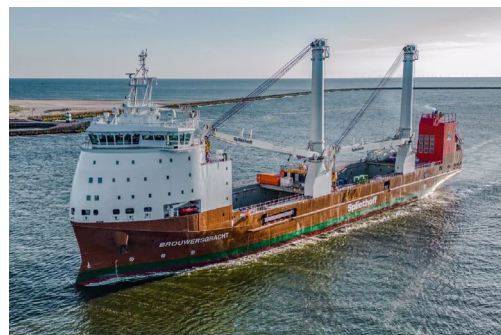

2023 BROUWERSGRACHT
BLOEMGRACHT

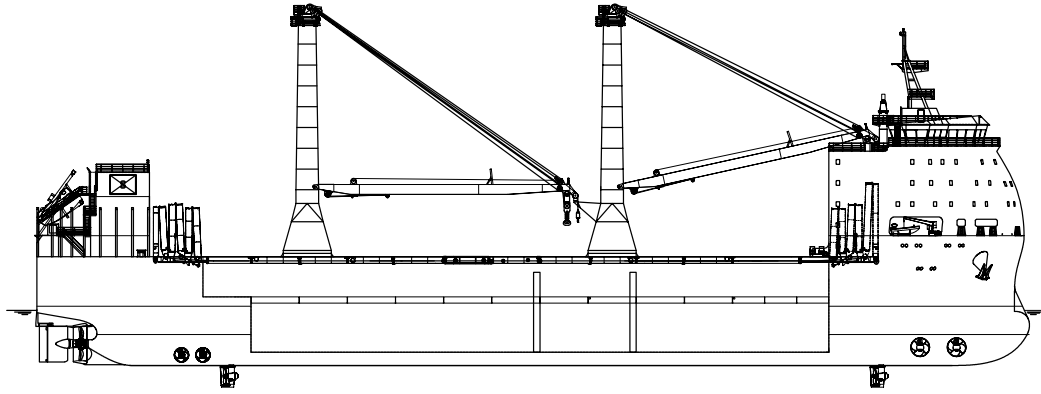

WEATHER DECK

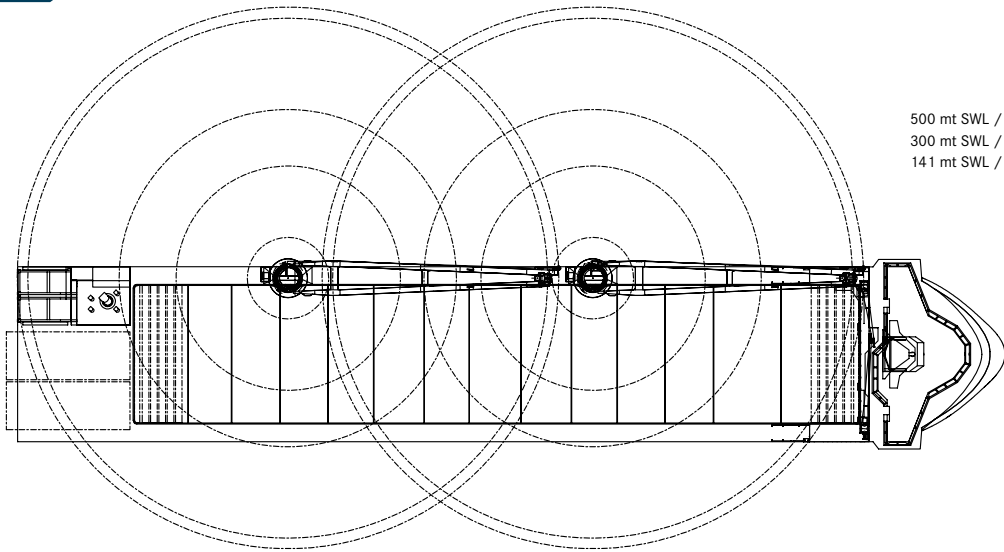

500 mt SWL / 16.5 m
 300 mt SWL / 27 m
 141 mt SWL / 37 m

TWEEN DECK

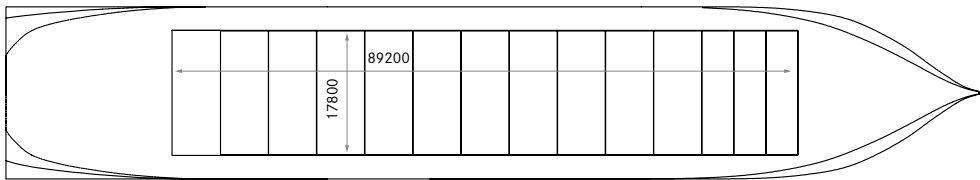

TANKTOP

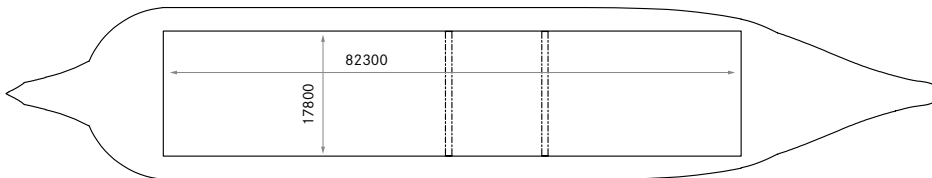

CROSS SECTION

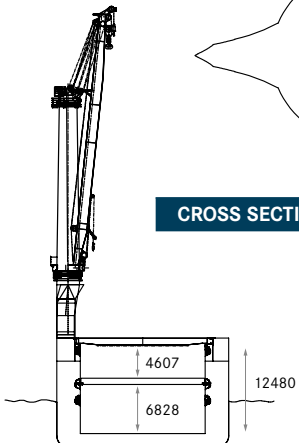

These particulars are believed to be correct, but without guarantee, and they must not be used as basis for Charter Parties or contracts without explicit written authority. For more information please contact amsterdam@spliothoff.com

B-TYPE